

Portable Ultrasonic Flow Measurement of Gas

Portable instrument for non-invasive, quick ultrasonic flow measurement with clamp-on technology for all types of piping

Features

- Non-invasive measurement using the clamp-on technology for precise bi-directional, highly dynamic flow measurement
- Portable, easy-to-use flow transmitter with 2 flow channels, multiple inputs/outputs, an integrated data logger with a serial interface in the standard version
- Automatic loading of calibration data and transducer detection reduce set-up times and provide precise, long-term stable results
- Li-Ion battery provides up to 14 hours of measurement operation
- Transducers available for a wide range of inner pipe diameters (7...1600 mm) and fluid temperatures (-40...+200 °C)
- Proven clamp-on technology, transducers resistant to dust and humidity
- Probe for wall thickness measurement available
- Water and dust-tight; resistant against oil, many liquids and dirt
- Robust, water-tight (IP 67) transport case with comprehensive accessories
- QuickFix for fast mounting of the flow transmitter in difficult conditions



FLUXUS G601 supported by handle

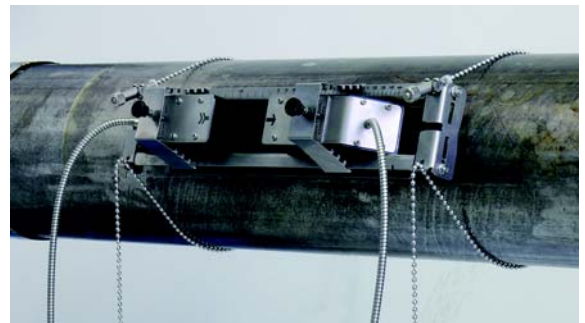

Measurement with transducers mounted by the portable Variofix VP

Applications

- Designed for industrial use in harsh environments, in gas processing and natural gas extraction, chemical industry and in the petroleum industry. Practical applications:
 - Measurement on natural gas pipelines and in natural gas storage installations
 - Measurement of synthesized gas and injection gas
 - Measurement for the gas supply industry
 - Supervision of permanently installed meters, service and maintenance



Measurement equipment in transport case

Table of Contents

Function	3
Measurement Principle	3
Calculation of Volumetric Flow Rate	3
Number of Sound Paths.....	4
Typical Measurement Setup	5
Standard Volumetric Flow Rate	5
Flow Transmitter	6
Technical Data	6
Dimensions	8
Standard Scope of Supply	9
Connection of Adapters	10
Example for the Equipment of a Transport Case	11
Transducers	12
Transducer Selection	12
Transducer Order Codes	15
Technical Data	16
Transducer Mounting Fixtures	20
Coupling Materials for Transducers	22
Damping Mats (optional)	23
Connection Systems	24
Transducer Cables	24
Temperature Probes (optional)	25
Wall Thickness Probe (optional)	27

Function

Measurement Principle

In order to measure the flow of a medium in a pipe, ultrasonic signals are used, employing the transit time difference principle. Ultrasonic signals are emitted by a transducer installed on one side of a pipe, reflected by the opposite pipe wall and received by a second transducer. These signals are emitted alternately in the flow direction and against it.

As the medium in which the signals propagate is flowing, the transit time of the ultrasonic signals in the flow direction is shorter than against the flow direction.

The transit time difference, Δt , is measured and allows the flowmeter to determine the average flow velocity along the propagation path of the ultrasonic signals. A flow profile correction is then performed in order to obtain the area averaged flow velocity, which is proportional to the volumetric flow rate.

The received ultrasonic signals will be checked for their usefulness for the measurement and the plausibility of the measured values will be evaluated. The complete measuring cycle is controlled by the integrated microprocessors. Disturbance signals will be eliminated.

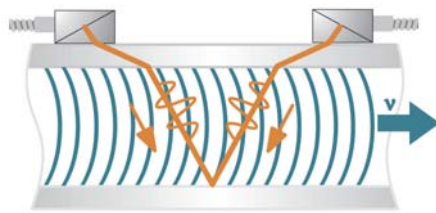

Path of the ultrasonic signal

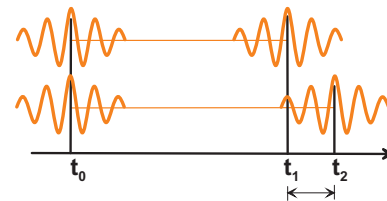

Transit time difference Δt

Calculation of Volumetric Flow Rate

$$Q = k_{Re} \cdot A \cdot k_a \cdot \Delta t / (2 \cdot t_{fl})$$

where:

- Q - volumetric flow rate
- k_{Re} - fluid mechanics calibration factor
- A - cross-sectional area of the pipe
- k_a - acoustical calibration factor
- Δt - transit time difference
- t_{fl} - transit time in the medium

Number of Sound Paths

The number of sound paths is the number of transits of the ultrasonic signal through the medium in the pipe. Depending on the number of sound paths, the following methods of installation exist:

- **reflection mode**

The number of sound paths is even. Both of the transducers are mounted on the same side of the pipe. Correct positioning of the transducers is easier.

- **diagonal mode**

The number of sound paths is odd. Both of the transducers are mounted on opposite sides of the pipe. In the case of a high signal attenuation by the medium, pipe and coatings, diagonal mode with 1 sound path will be used.

The preferred method of installation depends on the application. While increasing the number of sound paths increases the accuracy of the measurement, signal attenuation increases as well. The optimum number of sound paths for the parameters of the application will be determined automatically by the transmitter.

As the transducers can be mounted with the transducer mounting fixture in reflection mode or diagonal mode, the number of sound paths can be adjusted optimally for the application.

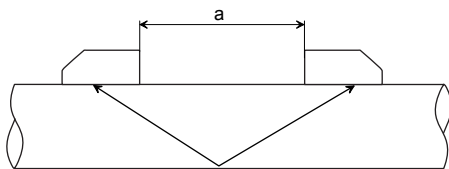

Reflection mode, number of sound paths: 2

a - transducer distance

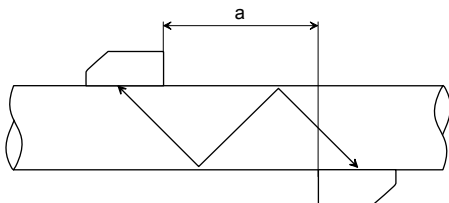

Diagonal mode, number of sound paths: 3

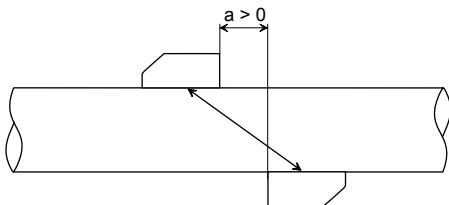

Diagonal mode , number of sound paths: 1

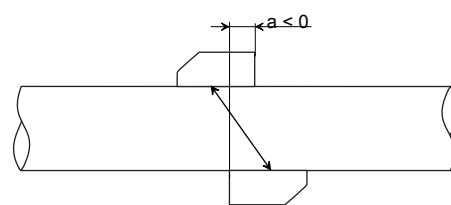

Diagonal mode , number of sound paths: 1,
negative transducer distance

Typical Measurement Setup

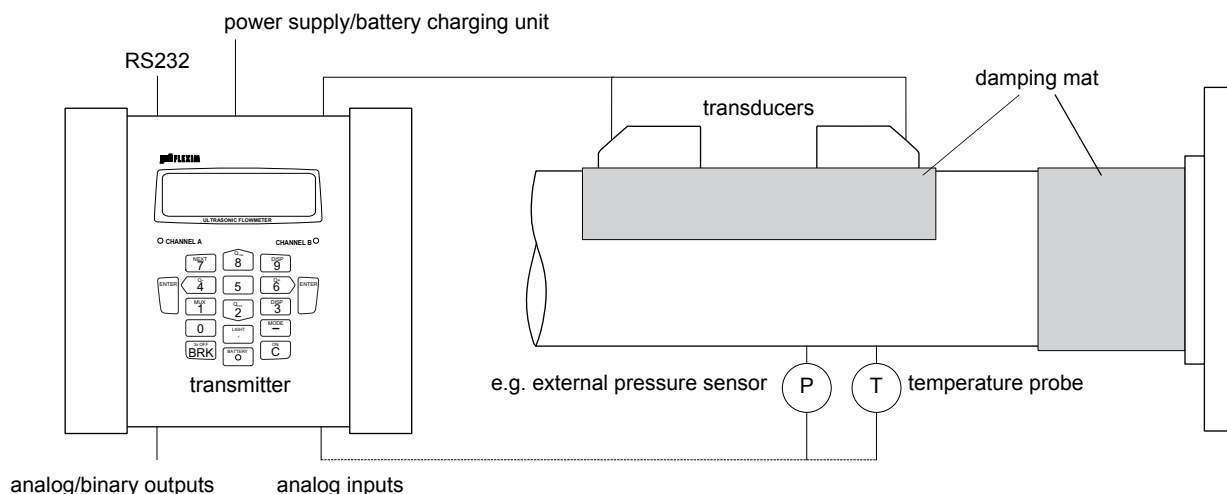

Example of a measurement setup in reflection mode with connection of the inputs to an external process pressure and process temperature measurement for standard volumetric flow rate calculation

Standard Volumetric Flow Rate

The standard volumetric flow rate can be selected as physical quantity to be measured. It will be calculated internally by:

$$V_N = V \cdot p/p_N \cdot T_N/T \cdot 1/K$$

where:

- V_N - standard volumetric flow rate
- V - operational volumetric flow rate
- p_N - standard pressure (absolute value)
- p - operational pressure (absolute value)
- T_N - standard temperature in K
- T - operational temperature in K
- K - gas compressibility factor

The operational pressure p and the operational temperature T of the medium will be entered directly as fixed values into the transmitter.

Or:

If inputs are installed (optional), pressure and temperature can be measured by the customer and fed in the transmitter.

The gas compressibility factor K will be entered in the transmitter:

- as fixed value or
- as approximation according to e.g. AGA8 or GERG

Flow Transmitter

Technical Data

FLUXUS	G601
design	portable
	
measurement	
measuring principle	transit time difference correlation principle
flow velocity	0.01...35 m/s, pipe diameter dependent
repeatability	0.15 % of reading ±0.01 m/s
accuracy	
- volumetric flow rate	± 1...3 % of reading ±0.01 m/s depending on application ± 0.5 % of reading ±0.01 m/s with field calibration
medium	gases with a ratio of the characteristic acoustic impedances of pipe wall and gas < 3000, e.g. nitrogen, air, oxygen, hydrogen, argon, helium, ethylene, propane
temperature compensation	corresponding to the recommendations in ANSI/ASME MFC-5M-1985
flow transmitter	
power supply	100...240 V/50...60 Hz (power supply), 10.5...15 V DC (socket at transmitter) or integrated battery
battery	Li-Ion, 7.2 V/4.5 Ah operating time (without outputs, inputs and backlight): > 14 h
power consumption	< 6 W
number of flow measuring channels	2
signal damping	0...100 s, adjustable
measuring cycle (1 channel)	100...1000 Hz
response time	1 s (1 channel), optional: 70 ms
housing material	PA, TPE, AutoTex, stainless steel
degree of protection according to EN 60529	IP 65
weight	1.9 kg
fixation	QuickFix pipe mounting fixture
operating temperature	-10...+60 °C
display	2 x 16 characters, dot matrix, backlit
menu language	English, German, French, Dutch, Spanish
measuring functions	
physical quantities	operational volumetric flow rate, standard volumetric flow rate, mass flow, flow velocity
totalizers	volume, mass
calculation functions	average, difference, sum
diagnostic functions	sound velocity, signal amplitude, SNR, SCNR, standard deviation of amplitudes and transit times
data logger	
loggable values	all physical quantities, totaled values and diagnostic values
capacity	> 100 000 measured values

FLUXUS	G601
communication	
interface	RS232/USB
serial data kit	
software (all Windows™ versions)	- FluxData: download of measured data, graphical presentation, conversion to other formats (e.g. for Excel™) - FluxKoef: creating medium data sets
cable	RS232
adapter	RS232 - USB
transport case	
dimensions	500 x 400 x 190 mm
outputs	
	The outputs are galvanically isolated from the transmitter.
number	see standard scopes of supply on page 9, max. on request
accessories	output adapter (if number of outputs > 4)
current output	
range	0/4...20 mA
accuracy	0.1 % of reading ±15 µA
active output	$R_{ext} < 200 \Omega$
passive output	$U_{ext} = 4...16 \text{ V}$, dependent on R_{ext} $R_{ext} < 500 \Omega$
frequency output	
range	0...5 kHz
open collector	24 V/4 mA
binary output	
optorelay	26 V/100 mA
binary output as alarm output - functions	limit, change of flow direction or error
binary output as pulse output - pulse value - pulse width	0.01...1 000 units 1...1 000 ms
inputs	
	The inputs are galvanically isolated from the transmitter.
number	see standard scopes of supply on page 9, max. 4
accessories	input adapter (if number of inputs > 2)
temperature input	
designation	Pt100/Pt1000
connection	4-wire
range	-150...+560 °C
resolution	0.01 K
accuracy	±0.01 % of reading ±0.03 K
current input	
range	passive: -20...+20 mA
accuracy	0.1 % of reading ±10 µA
passive input	$R_i = 50 \Omega$, $P_i < 0.3 \text{ W}$
voltage input	
range	0...1 V
accuracy	0.1 % of reading ±1 mV
internal resistance	$R_i = 1 \text{ M}\Omega$

Dimensions

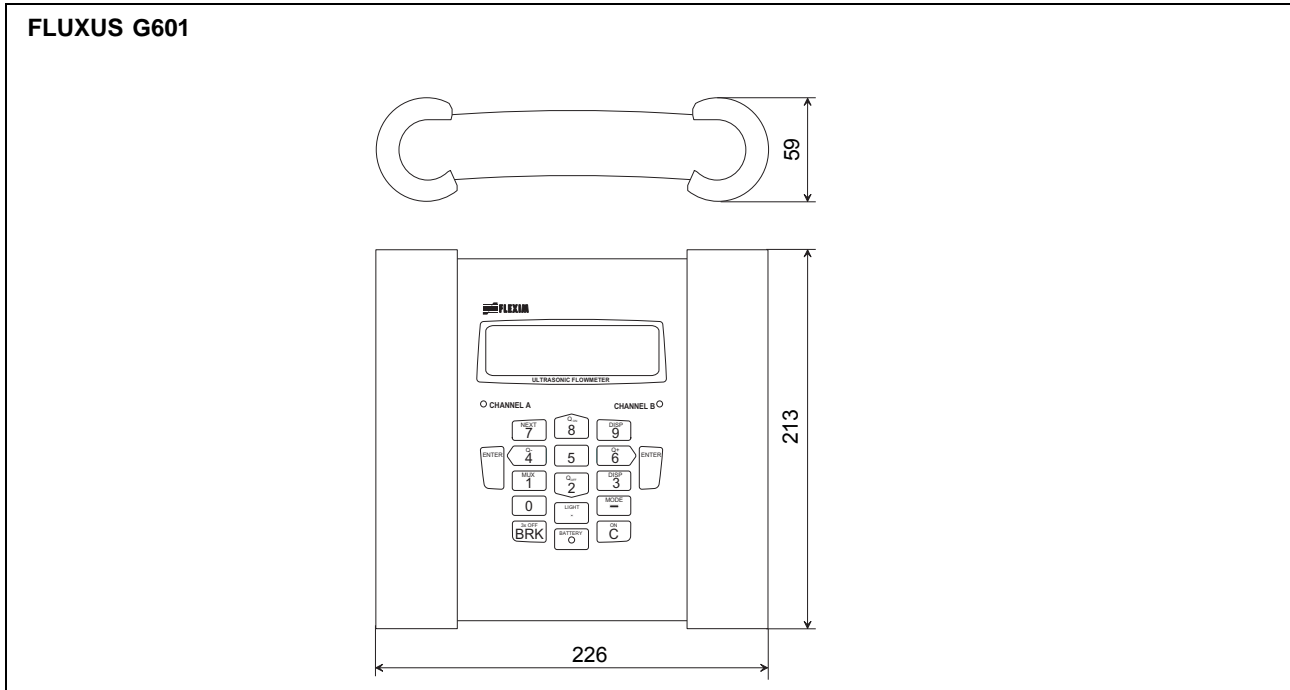

in mm

Standard Scope of Supply

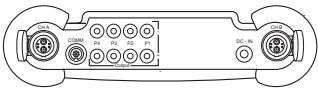
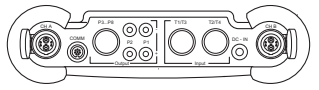
	G601 Standard	G601 Multifunctional
application	all flow measurements on gas	sophisticated measuring tasks, e.g. temporary substitute of other flowmeters with use of actual physical quantities (e.g. pressure, temperature) for calculation of the standard volumetric flow rate and simultaneous measured value output
outputs		
passive current output	2	2
binary output	2	2
frequency output	-	1
inputs		
temperature input	-	1
passive current input	-	2
voltage input	-	1
accessories		
transport case	x	x
power supply, power cable	x	x
battery	x	x
output adapter	-	x
input adapter	-	2
adapter for voltage or current inputs	-	3
QuickFix pipe mounting fixture for transmitter	x	x
serial data kit	x	x
measuring tape	x	x
damping mats with installation kit	x	x
wall thickness probe	-	x
user manual, Quick Start Guide	x	x
connector board at the upper side of the transmitter		

Connection of Adapters

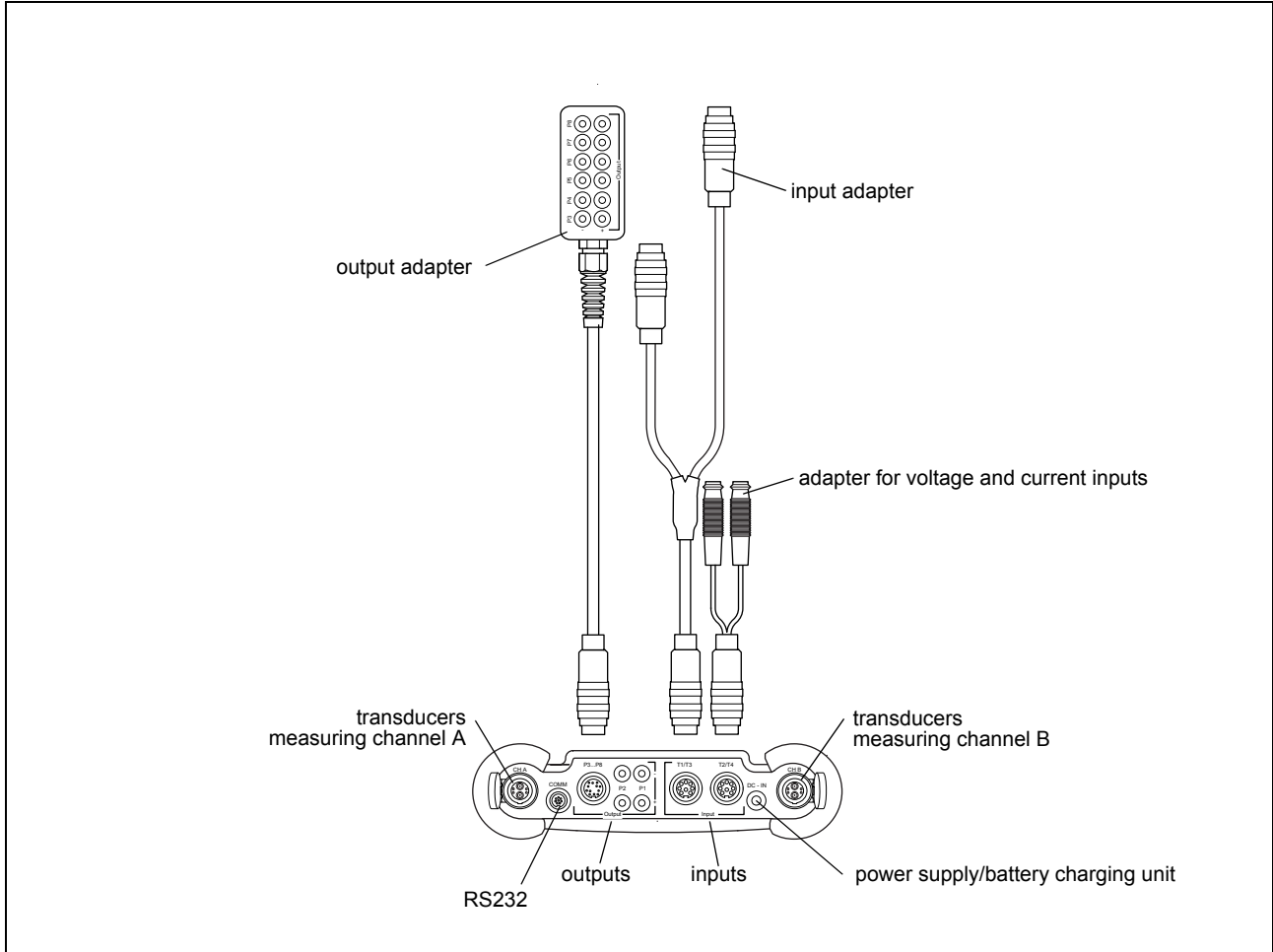

Example for the Equipment of a Transport Case



Transducers

Transducer Selection

Step 1a

Select a Lamb wave transducer:

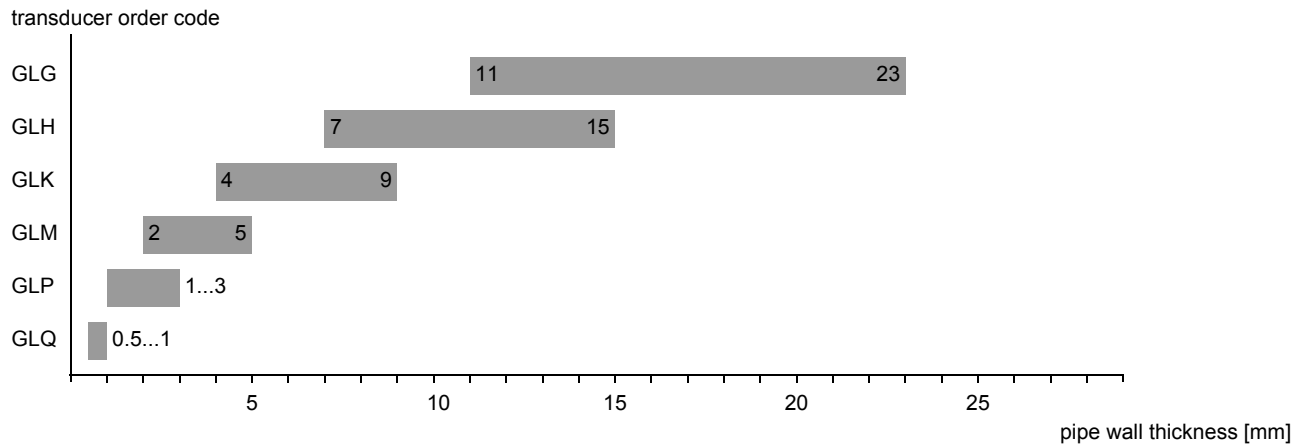

Step 1b

If the pipe wall thickness is not in the range of the Lamb wave transducers, select a shear wave transducer:

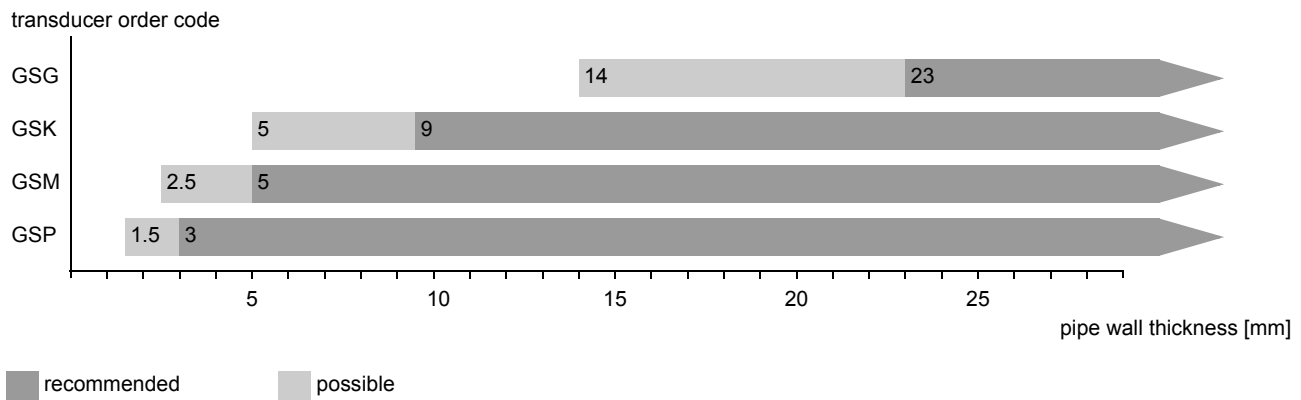

Step 2

inner pipe diameter d dependent on the flow velocity v of the medium in the pipe

The transducers are selected from the characteristics (see next page). Lamb wave transducers are selected from the left column, shear wave transducers from the right column.

Lamb wave transducers: If the values d and v are not in the range, diagonal mode with 1 sound path may be used, i.e. the same characteristics can be used with doubling the inner pipe diameter. If the values are still not in the range, shear waves transducers regarding the pipe wall thickness have to be selected in step 1b.

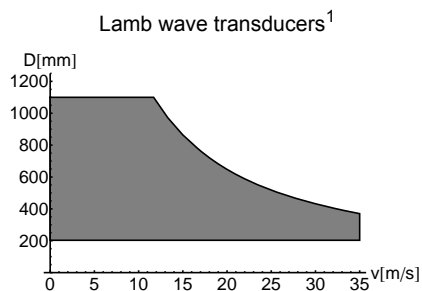

GLG

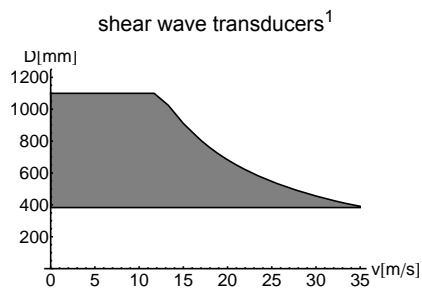

GSG

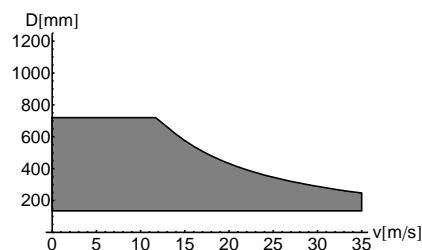

GLH

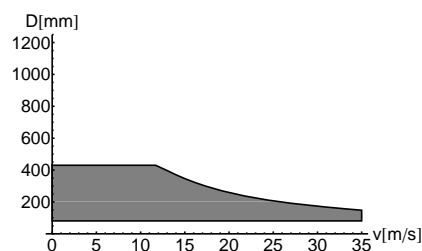

GLK

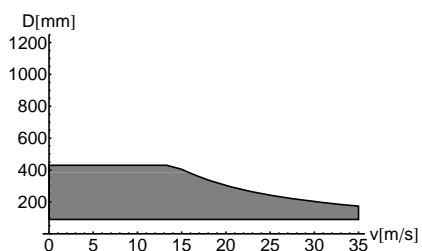

GSK

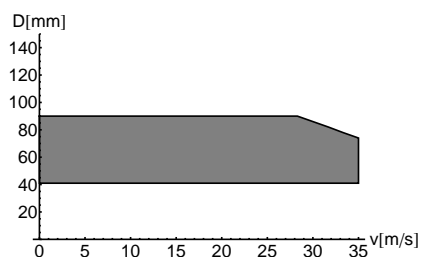

GLM

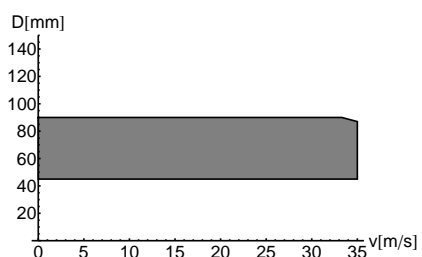

GSM

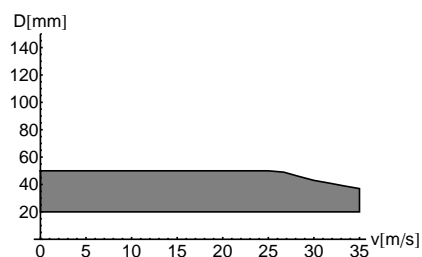

GLP

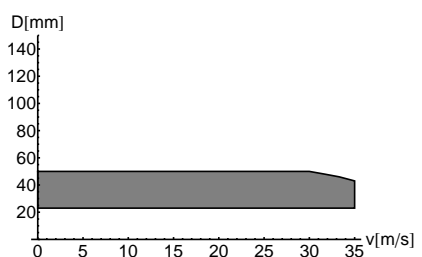

GSP

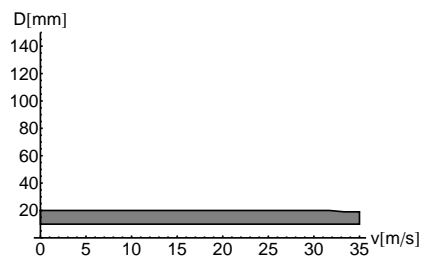

GLQ

¹ inner pipe diameter and max. flow velocity for a typical application with natural gas, nitrogen, oxygen in reflection mode with 2 sound paths (Lamb wave transducers)/1 sound path (shear wave transducers)

Step 3

min. medium pressure

Lamb wave transducers			
transducer order code	medium pressure ¹ [bar]		
	metal pipe		plastic pipe
	min.	min. extended	min.
GLG	15	10	1
GLH	15	10	1
GLK	15 (d > 120 mm) 10 (d < 120 mm)	10 (d > 120 mm) 5 (d < 120 mm)	1
GLM	10 (d > 60 mm) 5 (d < 60 mm)	-	1
GLP	10 (d > 35 mm) 5 (d < 35 mm)	-	1
GLQ	10 (d > 15 mm) 5 (d < 15 mm)	-	1

shear wave transducers			
transducer order code	medium pressure ¹ [bar]		
	metal pipe		plastic pipe
	min.	min. extended	min.
GSG	30	20	1
GSK	30	20	1
GSM	30	20	1
GSP	30	20	1

¹ depending on application, typical absolute value for natural gas, nitrogen, compressed air

d - inner pipe diameter

Examples

step						
1	pipe wall thickness selected transducer	mm	12 GLG or GLH	12 GLG or GLH	12 GLG or GLH	30 GS
2	inner pipe diameter max. flow velocity selected transducer	mm m/s	800 15 GLG	600 15 GLG or GLH	800 30 values not in the range of the characteristics, but by using diagonal mode with 1 sound path, the inner pipe diameter in the characteristics is doubled: GLG	300 15 GSK
3	min. medium pressure selected transducer	bar	17 GLG	17 GLG or GLH influence of noise is reduced with increased transducer frequency, thus recommended: GLH	17 GLG	35 GSK

Step 4

for determination of characters 4...11 of the transducer order code (temperature, explosion protection, connection system, extension cable) see page 15

Step 5

for the technical data of the selected transducer see page 16 et seqq.

Transducer Order Codes

1, 2	3	4	5, 6	7, 8	9...11	no. of character		
transducer	transducer frequency	-	temperature	explosion protection	connection system	-	extension cable	description
GL								set of ultrasonic flow transducers for gas measurement, Lamb wave
GS								set of ultrasonic flow transducers for gas measurement, shear wave
	G							0.2 MHz
	H							0.3 MHz (Lamb wave only)
	K							0.5 MHz
	M							1 MHz
	P							2 MHz
	Q							4 MHz (Lamb wave only)
		N						normal temperature range
		E						extended temperature range (shear wave transducers with transducer frequency M, Q)
			NN					not explosion proof
				NL				with Lemo connector
						XXX		cable length in m, for max. length of extension cable see page 24
example								
GL	K	-	N	NN	NL	-	000	Lamb wave transducer 0.5 MHz, normal temperature range, connection system NL with Lemo connector
		-				-		

Technical Data

Shear Wave Transducers

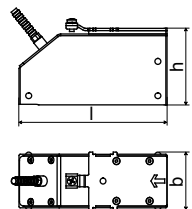
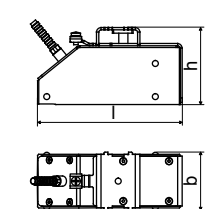
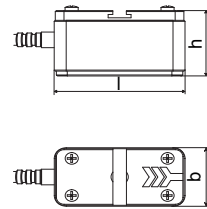
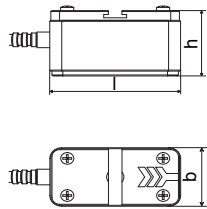
technical type		GDG1NZ7	GDK1NZ7	GDM1NZ7	GDP1NZ7	
order code		GSG-NNNNL	GSK-NNNNL	GSM-NNNNL	GSP-NNNNL	
transducer frequency		MHz 0.2	0.5	1	2	
medium pressure¹						
min. extended		bar	metal pipe: 20	metal pipe: 20	metal pipe: 20	
min.		bar	metal pipe: 30 plastic pipe: 1	metal pipe: 30 plastic pipe: 1	metal pipe: 30 plastic pipe: 1	
inner pipe diameter d²						
min. extended		mm	250	70	30	
min. recommended		mm	380	80	40	
max. recommended		mm	810	500	80	
max. extended		mm	1100	720	120	
pipe wall thickness						
min.		mm	14	5	2.5	
max.		mm	-	-	-	
material						
housing			PEEK with stainless steel cap 304 (1.4301)	PEEK with stainless steel cap 304 (1.4301)	stainless steel 304 (1.4301)	
contact surface			PEEK	PEEK	PEEK	
degree of protection according to EN 60529			IP 67	IP 67	IP 67	
transducer cable						
type			1699	1699	1699	
length		m	5	5	4	
dimensions						
length l		mm	129.5	126.5	60	
width b		mm	51	51	30	
height h		mm	67	67.5	33.5	
dimensional drawing						
operating temperature						
min.		°C	-40	-40	-40	
max.		°C	+130	+130	+130	
temperature compensation			x	x	x	

¹ depending on application, typical absolute value for natural gas, nitrogen, compressed air

² shear wave transducers:

typical values for natural gas, nitrogen, oxygen, pipe diameters for other gases on request

pipe diameter min. recommended/max. recommended/max. extended: in diagonal mode and for a flow velocity of 15 m/s

Shear Wave Transducers (extended temperature range)

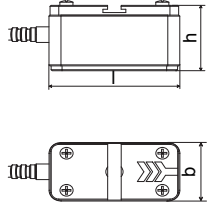
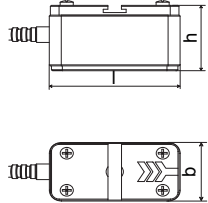
technical type		GDM1EZ7		GDP1EZ7	
order code		GSM-ENNNL		GSP-ENNNL	
transducer frequency		MHz	1		2
medium pressure¹					
min. extended		bar	metal pipe: 20	metal pipe: 20	
min.		bar	metal pipe: 30 plastic pipe: 1	metal pipe: 30 plastic pipe: 1	
inner pipe diameter d²					
min. extended		mm	30	15	
min. recommended		mm	40	20	
max. recommended		mm	80	40	
max. extended		mm	120	60	
pipe wall thickness					
min.		mm	2.5	1.5	
max.		mm	-	-	
material					
housing		stainless steel 304 (1.4301)		stainless steel 304 (1.4301)	
contact surface		Sintimid		Sintimid	
degree of protection according to IEC/EN 60529		IP65		IP65	
transducer cable					
type		1699		1699	
length		m	4	4	
dimensions					
length l		mm	60	60	
width b		mm	30	30	
height h		mm	33.5	33.5	
dimensional drawing					
operating temperature					
min.		°C	-30	-30	
max.		°C	+200	+200	
temperature compensation		x		x	

¹ depending on application, typical absolute value for natural gas, nitrogen, compressed air

² shear wave transducer:
 typical values for natural gas, nitrogen, oxygen, pipe diameters for other gases on request
 pipe diameter min. recommended/max. recommended/max. extended: in diagonal mode and for a flow velocity of 15 m/s

Lamb Wave Transducers

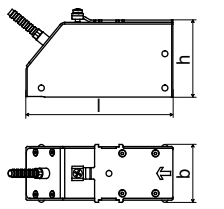
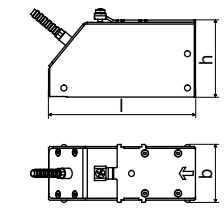
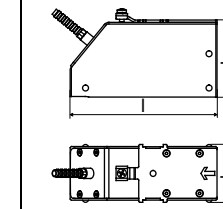
technical type		GRG1NC3	GRH1NC3	GRK1NC3
order code		GLG-NNNNL	GLH-NNNNL	GLK-NNNNL
transducer frequency		MHz 0.2	0.3	0.5
medium pressure¹				
min. extended	bar	metal pipe: 10	metal pipe: 10	metal pipe: 10 (d > 120 mm) 5 (d < 120 mm)
min.	bar	metal pipe: 15 plastic pipe: 1	metal pipe: 15 plastic pipe: 1	metal pipe: 15 (d > 120 mm) 10 (d < 120 mm) plastic pipe: 1
inner pipe diameter d²				
min. extended	mm	190	120	60
min. recommended	mm	220	140	80
max. recommended	mm	900	600	300
max. extended	mm	1600	1000	500
pipe wall thickness				
min.	mm	11	7	4
max.	mm	23	15	9
material				
housing		PPSU with stainless steel cap 304 (1.4301)	PPSU with stainless steel cap 304 (1.4301)	PPSU with stainless steel cap 304 (1.4301)
contact surface		PPSU	PPSU	PPSU
degree of protection according to EN 60529		IP 65	IP 65	IP 65
transducer cable				
type		1699	1699	1699
length	m	5	5	5
dimensions				
length l	mm	128.5	128.5	128.5
width b	mm	51	51	51
height h	mm	67.5	67.5	67.5
dimensional drawing				
operating temperature				
min.	°C	-40	-40	-40
max.	°C	+170	+170	+170
temperature compensation		x	x	x

¹ depending on application, typical absolute value for natural gas, nitrogen, compressed air

² Lamb wave transducers:
 typical values for natural gas, nitrogen, oxygen, pipe diameters for other gases on request
 pipe diameter min. recommended/max. recommended: in reflection mode and for a flow velocity of 15 m/s
 pipe diameter max. extended: in diagonal mode and for a flow velocity of 25 m/s

Lamb Wave Transducers

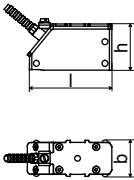
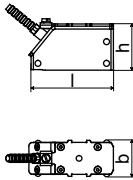
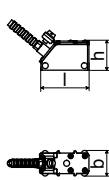
technical type		GRM1NC3	GRP1NC3	GRQ1NC3
order code		GLM-NNNNL	GLP-NNNNL	GLQ-NNNNL
transducer frequency	MHz	1	2	4
medium pressure¹				
min. extended min.	bar	-	-	-
	bar	metal pipe: 10 (d > 60 mm) 5 (d < 60 mm) plastic pipe: 1	metal pipe: 10 (d > 35 mm) 5 (d < 35 mm) plastic pipe: 1	metal pipe: 10 (d > 15 mm) 5 (d < 15 mm) plastic pipe: 1
inner pipe diameter d²				
min. extended	mm	30	15	7
min. recommended	mm	40	20	10
max. recommended	mm	90	50	22
max. extended	mm	150	70	35
pipe wall thickness				
min.	mm	2	1	0.5
max.	mm	5	3	1
material				
housing		PPSU with stainless steel cap 304 (1.4301)	PPSU with stainless steel cap 304 (1.4301)	PPSU with stainless steel cap 304 (1.4301)
contact surface		PPSU	PPSU	PPSU
degree of protection according to EN 60529		IP 65	IP 65	IP 65
transducer cable				
type		1699	1699	1699
length	m	4	4	3
dimensions				
length l	mm	74	74	42
width b	mm	32	32	22
height h	mm	40.5	40.5	25.5
dimensional drawing				
operating temperature				
min.	°C	-40	-40	-40
max.	°C	+170	+170	+170
temperature compensation		x	x	x
remark				on request

¹ depending on application, typical absolute value for natural gas, nitrogen, compressed air

² Lamb wave transducers:

typical values for natural gas, nitrogen, oxygen, pipe diameters for other gases on request

pipe diameter min. recommended/max. recommended: in reflection mode and for a flow velocity of 15 m/s

pipe diameter max. extended: in diagonal mode and for a flow velocity of 25 m/s

Transducer Mounting Fixtures

Order Codes

1, 2	3	4	5	6	7...9	no. of character		
transducer mounting fixture	transducer	-	measuring mode	size	-	fixation	outer pipe diameter	description
TB								tension belts
VP								portable Variofix
	A							all transducers
			D					reflection mode or diagonal mode
			R					reflection mode
				M				medium
						C		chains
						N		without fixation
							055	10...550 mm
							150	50...1500 mm
							210	50...2100 mm
example								
VP	A	-	D	M	-	C	055	portable Variofix and chains
		-			-			

Portable Variofix VP and Chains

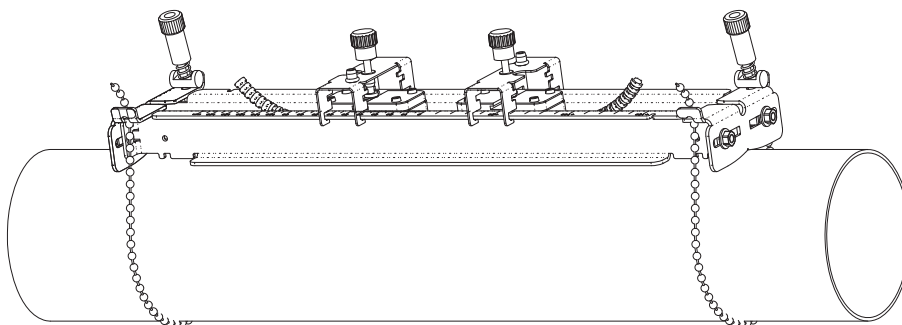

material: stainless steel 304 (1.4301), 301 (1.4310), 303 (1.4305)
 dimensions: 414 x 84 x 50 mm
 chain length: 2 m

Portable Variofix VP and Magnets (optional)

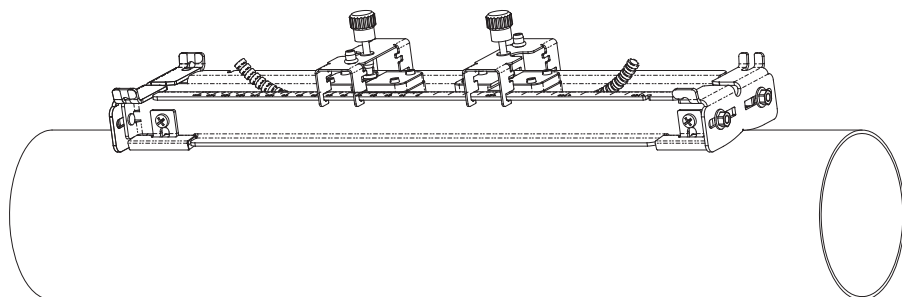

material: stainless steel 304 (1.4301), 301 (1.4310), 303 (1.4305)
 dimensions: 414 x 84 x 45 mm

Tension Belts TB

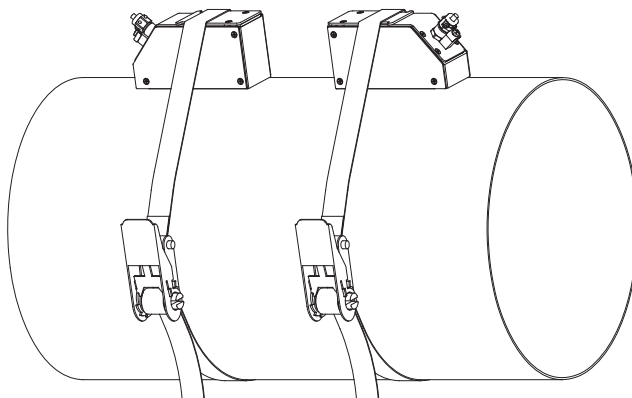

material: steel, powder coated and textile belt
 length: 5/7 m
 temperature: max. 60 °C
 outer pipe diameter: max. 1500/2100 mm

Coupling Materials for Transducers

	normal temperature range (4th character of transducer order code = N)		extended temperature range (4th character of transducer order code = E)	
	< 100 °C	100...170 °C	< 150 °C	150...200 °C
< 2 h	coupling compound type N	coupling compound type E	coupling compound type E	coupling compound type E or H
< 24 h	coupling compound type N	coupling compound type E	coupling compound type E	coupling foil type VT
< 3 months	coupling compound type N	coupling compound type E	coupling foil type VT	coupling foil type VT

Technical Data

type	order code	temperature °C	material	remark
coupling compound type N	990739-1	-30...+130	mineral grease paste	
coupling compound type E	990739-2	-30...+200	silicone paste	
coupling compound type H	990739-3	-30...+250	fluoropolymer paste	
coupling foil type VT	990739-0	-10...+150, peak max. 200	fluoroelastomer	for transducers with transducer frequency G, H, K
	990739-6			for shear wave transducers with transducer frequency M, P
	990739-14			for IP 68 shear wave transducers and Lambwave transducers with transducer frequency M, P
	990739-15			for shear wave transducers with transducer frequency Q
	990739-5			for Lambwave transducers with transducer frequency Q

coupling foil not to be used for transducer mounting fixture with magnets

Damping Mats (optional)

Damping mats will be used for the gas measurement to reduce noise influences on the measurement.

Transducer damping mats will be installed below the transducers.

Pipe damping mats will be installed at reflection points, e.g. flange, weld.

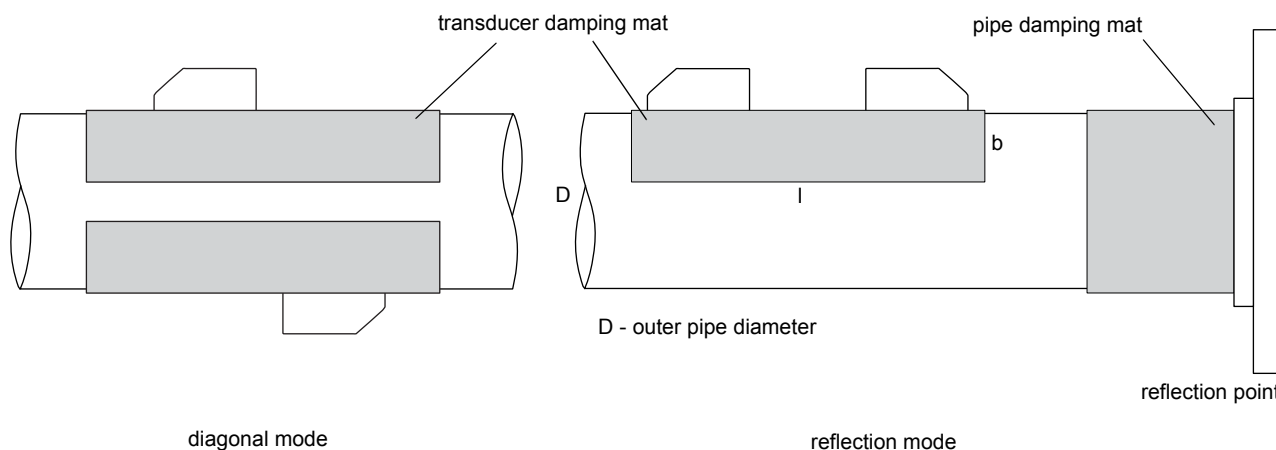

Selection of Damping Mats

type	description	outer pipe diameter mm	dimensions l x b x h mm	transducer frequency (3rd character of transducer order code)					technical type	temperature °C	remark
				G	H	K	M	P			
transducer damping mat											
D	for temporary installation (multiple use), fixed with coupling compound	< 80	450 x 115 x 0.5	-	-	-	x	x	D20S3	-25...+60	
		≥ 80	900 x 230 x 0.5	-	-	x	x	-	D20S2		
			900 x 230 x 1.3	x	x	-	-	-	D50S2		
pipe damping mat											
A	for temporary installation (multiple use), fixed with coupling compound	< 300	300 x 100 x 0.5	x	x	x	x	x	A20S4	-25...+60	for quantity see table below
B	self-adhesive	≥ 300	l x 100 x 0.9	x	x	x	x	x	B35R2	-35...+50	l - see table below

Quantity for Pipe Damping Mat - Type A

(depending on the outer pipe diameter)

outer pipe diameter D mm	transducer frequency	
	G, H	K, M, P
100	13	7
200	26	13
300	38	19

Length of Pipe Damping Mat - Type B

(length l depending on transducer frequency and outer pipe diameter)

outer pipe diameter D mm	transducer frequency	
	G, H m	K, M, P m
300	12	6
500	32	16
1000	126	63

Connection Systems

Connection System NL

transducer frequency (3rd character of transducer order code)		G, H, K			M, P			Q			S		
cable length	m	x	y	l ¹	x	y	l ¹	x	y	l ¹	x	y	l
		2	3	≤ 25	2	2	≤ 25	2	1	≤ 25	1	1	≤ 20

¹ > 25...100 m on request

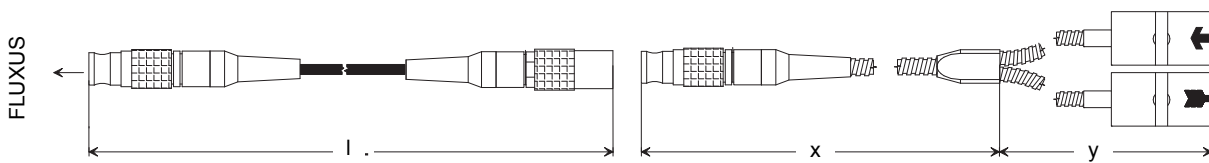

x, y - transducer cable length
l - max. length of extension cable

Transducer Cables

Technical Data

		transducer cable	extension cable
item number		1699	2551
standard length	m	see table above	5 10
max. length	m	-	see table above
temperature	°C	-55...+200	-25...+80
sheath			
material		stainless steel 304 (1.4301)	-
outer diameter	mm	8	-
cable jacket			
material		PTFE	TPE-O
outer diameter	mm	2.9	8
thickness	mm	0.3	
color		brown	black
shield		x	x

Temperature Probes (optional)

Technical Data

order code		670415-1	670414-1	670415-2	670414-2
type		Pt100	Pt100 matched according to DIN 1434-1	Pt100	Pt100 matched according to DIN 1434-1
design		4-wire		4-wire	
measuring range	°C	-30...+250		-50...+250	
accuracy T		$\pm(0.15 \text{ °C} + 2 \cdot 10^{-3} \cdot T \text{ [°C]})$, class A		$\pm(0.15 \text{ °C} + 2 \cdot 10^{-3} \cdot T \text{ [°C]})$, class A	
accuracy ΔT		-	$\leq 0.1 \text{ K}$ ($3\text{K} < \Delta T < 6 \text{ K}$), more corresponding to EN 1434-1	-	$\leq 0.1 \text{ K}$ ($3\text{K} < \Delta T < 6 \text{ K}$), more corresponding to EN 1434-1
response time	s	50		8	
housing		aluminum		PEEK, stainless steel 304 (1.4301), Cu	
degree of protection according to EN 60529		IP 66		IP 66	
weight (without connector)	kg	0.25	0.5	0.32	0.64
fixation		clamp-on		clamp-on	
accessories		-		plastic protection plate, isolation foam	
dimensions					
length l	mm	15		14	
width b	mm	15		30	
height h	mm	20		27	
dimensional drawing		A		B	

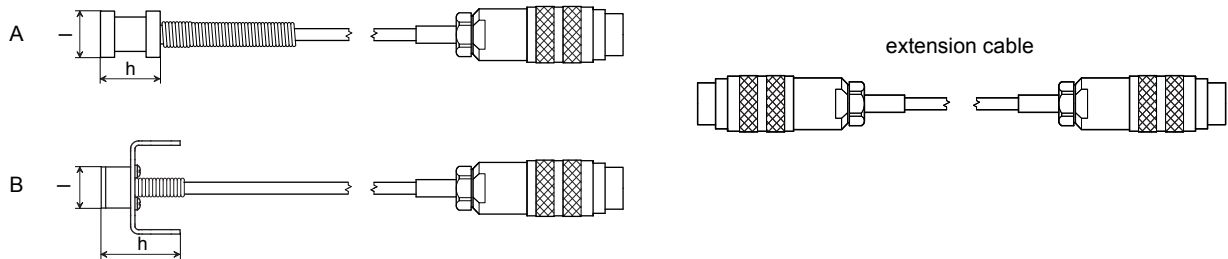

Connection

Temperature Probe

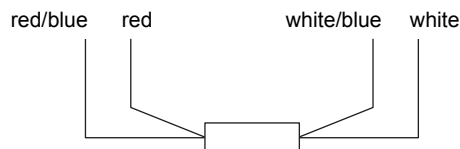

Connector

pin	cable of temperature probe	extension cable
1	white/blue	blue
2	red/blue	gray
3, 4, 5	not connected	
6	red	red
7	white	white
8	not connected	

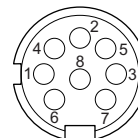

Cables

		cable of temperature probe	extension cable
type		4 x 0.25 mm ² black or white	LIYCY 8 x 0.14 mm ² gray
standard length	m	3	5/10/25
max. length	m	-	200
cable jacket		PTFE	PVC

Wall Thickness Probe (optional)

The pipe wall thickness is an important pipe parameter which has to be determined exactly for a good measurement. However, the pipe wall thickness often is unknown.

The wall thickness probe can be connected to the flow transmitter instead of the flow transducers and the wall thickness measurement mode is activated automatically.

Acoustic coupling compound is applied to the wall thickness probe which then is placed firmly on the pipe. The wall thickness is displayed and can be stored directly in the flow transmitter.



Wall thickness measurement

Technical Data

technical type		DWQ1xZ7	DWP1EZ7
		reverse polarity protected	
measuring range ¹	mm	1...200	
resolution	mm	0.01	
linearity	mm	0.1	
operating temperature	°C	-20...+60	-20...+200, peak max. 540
cable length	m	1.5	1.2

¹ The measuring range depends on the attenuation of the ultrasonic signal in the pipe. For strongly attenuating plastics (e.g. PFA, PTFE, PP) the measuring range is smaller.

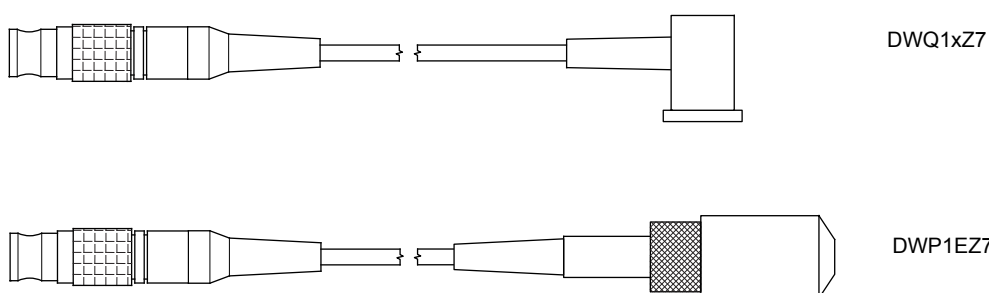



FLEXIM GmbH
Wolfener Str. 36
12681 Berlin
Germany
Tel.: +49 (30) 93 66 76 60
Fax: +49 (30) 93 66 76 80

internet: www.flexim.com
e-mail: info@flexim.com

Subject to change without notification. Errors excepted.
FLUXUS® is a registered trademark of FLEXIM GmbH.
2011-03-10, TSFLUXUS_G601V1-4-1EN_Leu